

RICCAR®

The Butler

Owner's Manual



- IMPORTANT SAFETY INSTRUCTIONS** 2
 - Polarization Instructions 3
 - Description of the Vacuum 4

- Operation**
 - Turning the Vacuum On/Off 6
 - Carrying the Vacuum 6
 - Power Cord Storage 6
 - Vacuuming Floors 7

- Attachment Cleaning**
 - Cleaning Tools 8
 - Cleaning Tools Holder 8
 - Adjusting the Suction Power 9
 - Using the Blower Exhaust Port 9
 - Micro Tool Kit and Angle Adapter 10

- Maintenance and Care**
 - Replacing the Vacuum Bag 11
 - When to Change the Filter 12
 - Replacing the Filter 12

- Problem Solving Guide**
 - Troubleshooting 13
 - How to Contact Your Authorized Retailer 13
 - Visit Riccar Online 13

- Warranty** 14

IMPORTANT SAFETY INSTRUCTIONS

When using an electrical appliance, basic precautions should always be followed, including the following:

READ ALL INSTRUCTIONS BEFORE USING THIS APPLIANCE

The manufacturer cannot accept responsibility for damage caused when the appliance is not used according to the instructions or for uses other than those for which it was intended.

To reduce the risk of fire, electric shock or injury:

- Do not leave appliance when plugged in. Unplug from outlet when not in use and before servicing.
- Do not handle plug or appliance with wet hands.
- **WARNING: ELECTRIC SHOCK COULD OCCUR IF USED OUTDOORS OR ON WET SURFACES.**
- Do not put any object into openings. Do not use with any opening blocked; keep free of dust, lint, hair and anything that may reduce air flow.
- Do not allow to be used as a toy. Close attention is necessary when used by or near children.
- Keep hair, loose clothing, fingers and all parts of body away from openings and moving parts.
- Use only as described in this manual. Use only manufacturer's recommended attachments.
- Do not pick up anything that is burning or smoking, such as cigarettes, matches or hot ashes.
- Do not use with damaged cord or plug. If appliance is not working as it should, has been dropped, damaged, left outdoors, or dropped into water, return it to your Authorized Retailer for service.
- Do not use without vacuum bag and/or filter in place.
- Do not pull or carry by cord, use cord as a handle, close a door on the cord, or pull cord around sharp edges or corners. Do not run appliance over cord. Keep cord away from heated surfaces.
- Turn off all controls before unplugging.
- Do not unplug by pulling on cord. To unplug, grasp the plug, not the cord.
- Use extra care when cleaning on stairs.
- Do not use to pick up flammable or combustible liquids, such as gasoline, or use in areas where they may be present.
- Do not attempt to service the unit while appliance is plugged in.

SAVE THESE INSTRUCTIONS.

Polarization Instructions

POWER CORD, 2-WIRE POLARIZED CORD

To reduce the risk of electric shock, this product is equipped with a polarized alternating current line plug (a plug having one blade wider than the other). This plug will fit into the power outlet only one way. This is a safety feature. If you are unable to insert the plug fully into the outlet, try reversing the plug. If the plug should still fail to fit, contact a qualified electrician to replace the obsolete outlet. Do not defeat the safety purpose of the polarized plug.

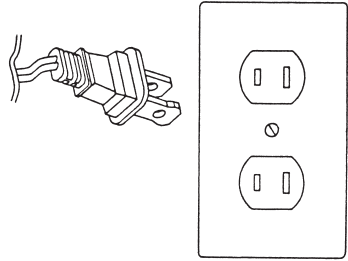

State of California Proposition 65 Warnings:

WARNING: This product contains one or more chemicals known to the State of California to cause cancer.

WARNING: This product contains one or more chemicals known to the State of California to cause birth defects or other reproductive harm.

Description of the Vacuum

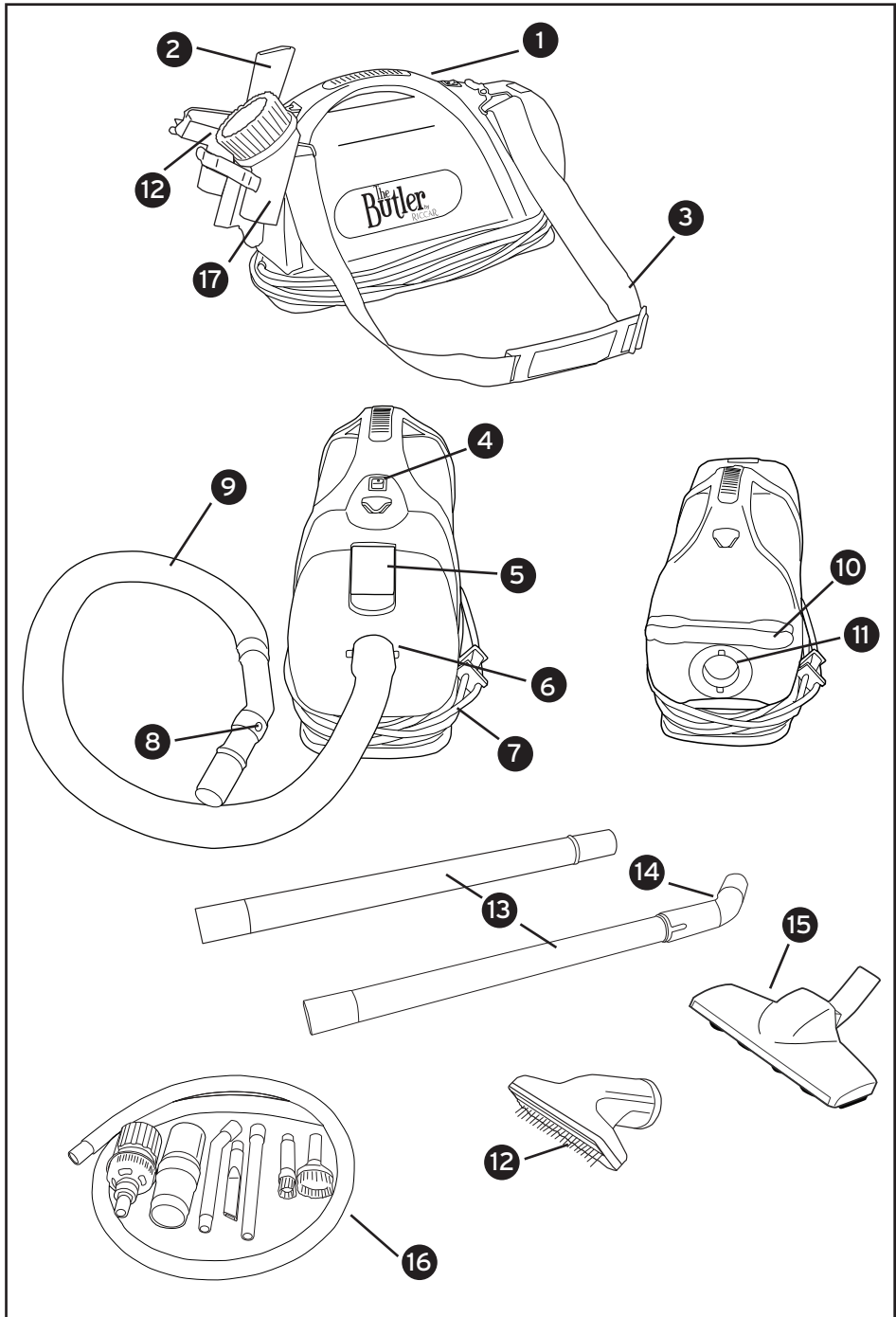

Description of the Vacuum

- 1 Carrying Handle
- 2 Crevice Tool
- 3 Shoulder Strap
- 4 Main On/Off Power Switch
- 5 Bag Compartment Cover and Retaining Latch
- 6 Suction Intake Port
- 7 Power Cord / Cord Storage
- 8 Suction Relief Ring
- 9 Hose Assembly
- 10 Cleaning Tools Holder
- 11 Blower Exhaust Port
- 12 Upholstery Tool
- 13 Extension Wands
- 14 Adjustable Angle Adapter
- 15 Bare Floor Tool
- 16 Micro Tool Kit
- 17 Dusting Brush

Operation

Turning the Vacuum On/Off (Fig. 1)

- To start the vacuum cleaner, push the “On/Off” switch located on the handle to the “On” (I) position.
- To stop the vacuum cleaner, push the “On/Off” switch to the “Off” (O) position.
- Turn the vacuum cleaner off before unplugging from electrical outlet.

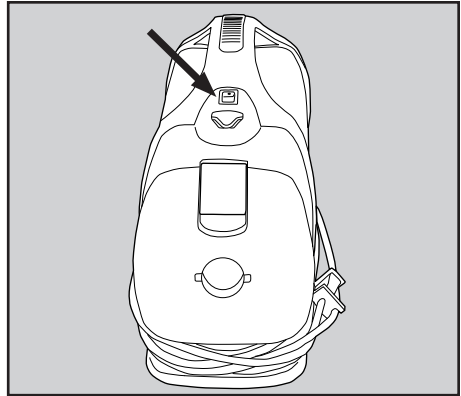

Fig. 1

Carrying the Vacuum (Fig. 2)

To safely transport your vacuum, especially when carrying the vacuum up and down stairs, use the carry handle and/or the shoulder strap.

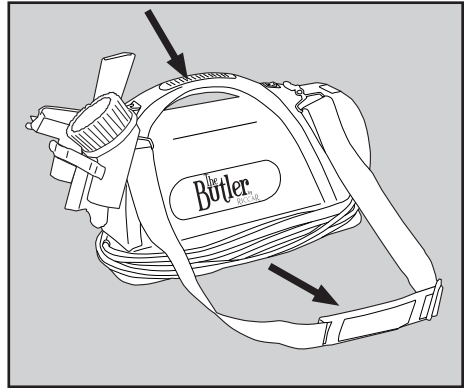

Fig. 2

Storing the Power Cord (Fig. 3)

The power cord conveniently wraps around the base of the vacuum for easy storage.

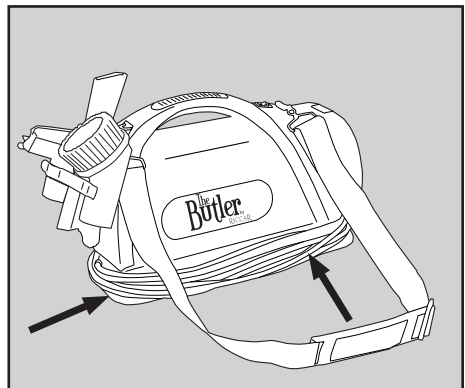

Fig. 3

Vacuuming Floors

With the cleaning tools and vacuum wands, your vacuum is a comprehensive cleaning system.

- Attach the vacuum hose to the suction inlet port and twist to lock into place (Fig. 4).
- Attach the extension wand(s) to the curved handle end of the hose (Fig. 5).
- Attach the floor tool to the end of the extension wand(s) for cleaning floors and area rugs (Fig. 6).

NOTE: You can connect any of the cleaning tools to the end of the extension wand(s) and twist for a secure fit. To remove the cleaning tool from the extension wand(s) simply twist and pull apart.

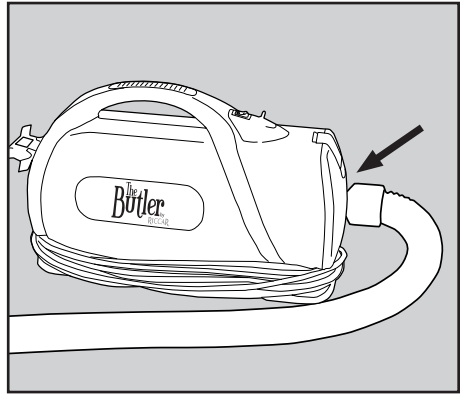

Fig. 4

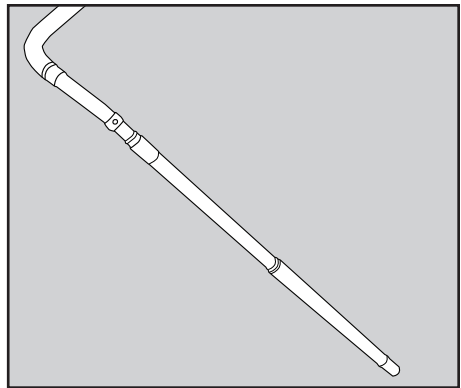

Fig. 5

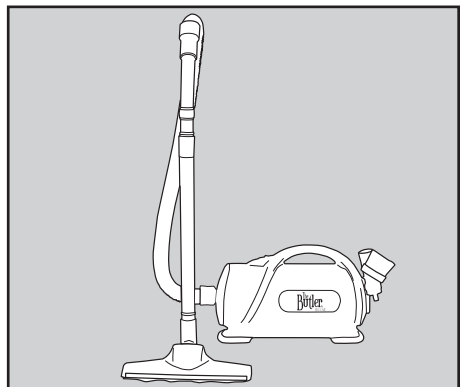

Fig. 6

Attachment Cleaning

Cleaning Tools

Your vacuum is equipped with a deluxe dusting brush, upholstery tool and crevice tool. Other tools are available at your Authorized Riccar Retailer.

- Attach the vacuum hose to the suction inlet port and twist to lock into place (Fig. 4).
- Attach the extension wand(s) to the curved handle end of the hose (Fig. 5).
- Insert any of the tools onto the end of the wand(s).

Dusting Brush (Fig. 7)

Ideal for table tops, shelves, blinds or hard surface floors.

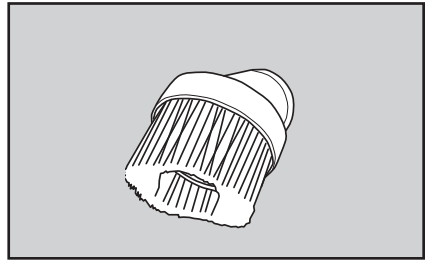

Fig. 7

Upholstery Tool (Fig. 8)

Ideal for soft surfaces like chairs and couches.

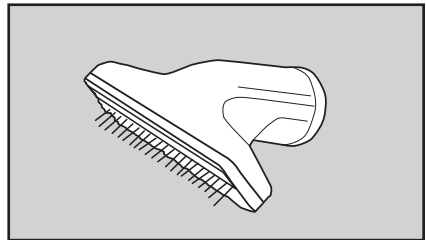

Fig. 8

Crevice Tool (Fig. 9)

Ideal for tight places like between seat cushions or corners.

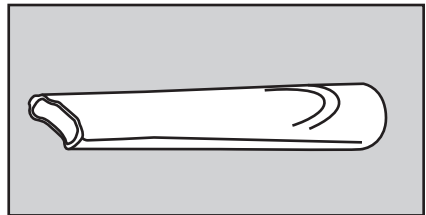

Fig. 9

Cleaning Tools Holder (Fig. 10)

Your vacuum is equipped with a convenient holder for the cleaning tools.

- Slide the holder onto the clip above the blower exhaust port and attach the tools onto the holder.

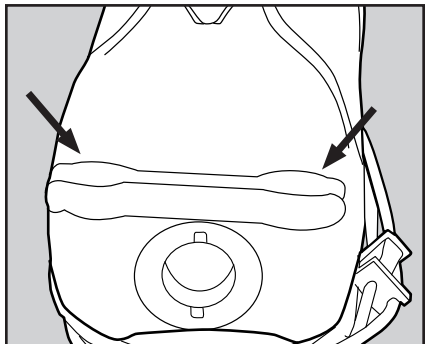

Fig. 10

Adjusting the Suction Power for Tool Cleaning (Fig. 11)

On the hose handle, locate the suction relief ring and turn it to the desired position. This reduces the suction power coming through the hose. Close the suction relief ring when finished to restore full suction power.

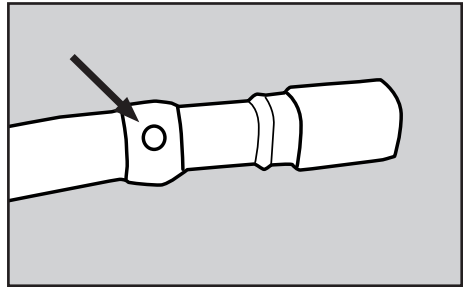

Fig. 11

Using the Blower Exhaust Port

Attach the vacuum hose to the blower exhaust port (Fig. 12). Then, attach the inflation adapter (included in the micro tool kit) to the end of the hose for inflating mattresses, rafts, etc (Fig. 13).

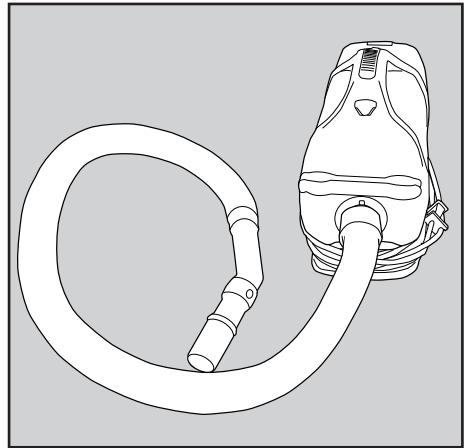

Fig. 12

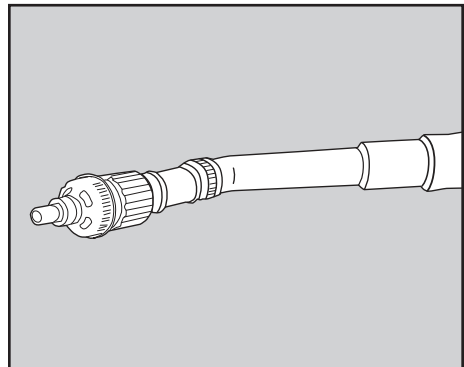

Fig. 13

Attachment Cleaning

Additional Cleaning Tools

The micro tool kit and adjustable angle adapter are standard accessories with your vacuum.

Micro Tool Kit (Fig. 14)

All the tools needed for cleaning delicate collectibles, computer keyboards or inflating an air mattress.

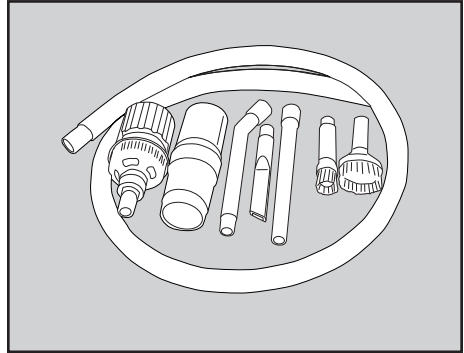

Fig. 14

Adjustable Angle Adapter (Fig. 15)

Attach the angle adapter onto the end of the wand to clean hard to reach areas.

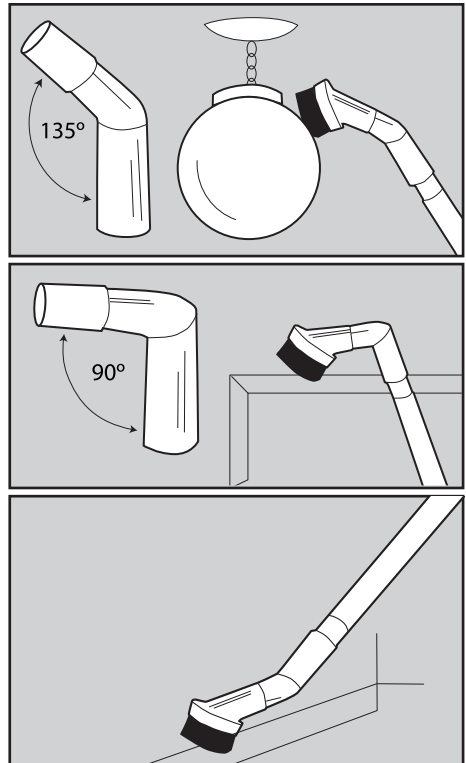

Fig. 15

Replacing the Vacuum Bag

- Lift up the cover retaining clip to remove the cover (Fig. 16).
- Remove and discard the used bag.
- Install a new bag with the arrow on the cardboard pointing to the top of the vacuum (Fig. 17).
- Replace the cover and latch the retaining clip.

NOTE: The vacuum bag cannot be reused.

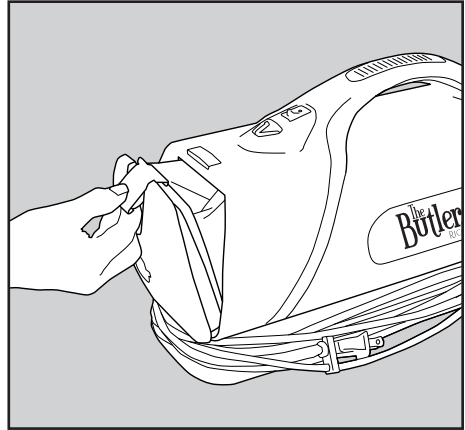

Fig. 16

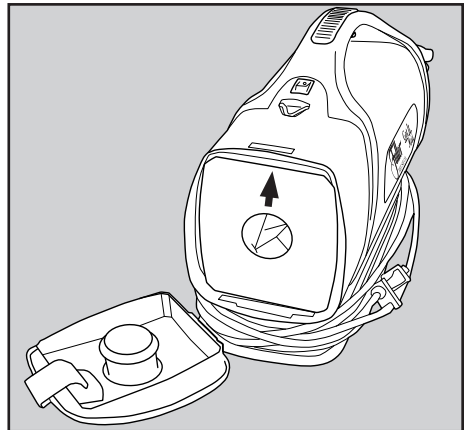

Fig. 17

Maintenance and Care

When to Change the Filter

At a minimum, it's recommended to replace the filters once a year or after using 12 vacuum bags, whichever comes first.

If someone in your household is sensitive to airborne allergens, it is recommended to change the filter after every six vacuum bags.

Replacing the Charcoal Filter

- Lift up the cover retaining clip to remove the cover (Fig. 18).
- Remove the bag.
- Remove and discard the used filter from the inside back wall of the vacuum.
- Place the new charcoal filter in the back wall of the vacuum. It should fit snugly against the inside walls of the vacuum (Fig. 19).
- Replace the vacuum bag.
- Replace the cover and latch retaining clip.

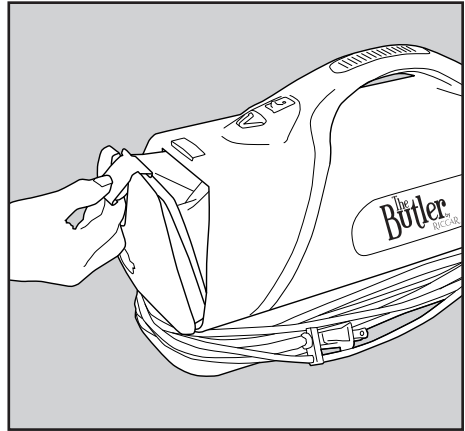

Fig. 18

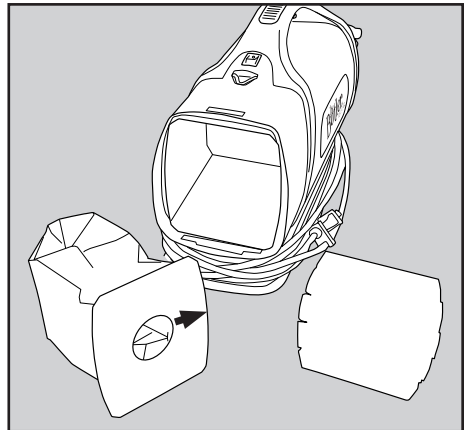

Fig. 19

Troubleshooting

PROBLEM	POSSIBLE REASON	POSSIBLE SOLUTION
Vacuum won't turn on	• Power cord not firmly plugged in	• Plug unit in firmly
	• Blown fuse or tripped breaker	• Check house fuse or breaker. Replace fuse / reset breaker.
	• Needs service	• Take to Authorized Retailer (1-888-6-RICCAR)
Vacuum won't pick up or low suction	• Vacuum bag full	• Install new bag
	• Clogged filter	• Install new filter
	• Hose clogged	• Remove obstacle
Dust escaping from vacuum	• Bag compartment cover not installed properly	• Reinsert the cover and secure latch
	• Filter not installed correctly	• Review filter installation (page 12)
	• Vacuum bag not installed correctly	• Review bag installation (page 11)
<p>Any other service should be done by an Authorized Service Representative.</p> <p>Service 1-888-6-RICCAR</p> <p>To locate your nearest retailer, visit our website at www.riccar.com</p>		

Warranty

What is Covered:

This warranty covers any defects in material and workmanship in your new Riccar Butler vacuum.

How Long Coverage Lasts:

Warranty coverage for the Riccar Butler vacuum lasts three years. Household models used commercially are only warranted for 90 days.

What is Not Covered:

- Damage to the vacuum which occurs from neglect, abuse, alterations, accident, misuse or improper maintenance.
- Normal replacement items: disposable bags and disposable filters.

What Riccar Vacuums Will Do:

This warranty provides, at no cost to you, all labor and parts to keep this vacuum in correct operating condition during the warranted period.

How to Get Service:

Warranty service can only be obtained by presenting the vacuum to an Authorized Riccar Retailer. A proof-of-purchase and product serial number will be required before service is rendered. **To locate your nearest Riccar Retailer, please call 1-888-6-RICCER or visit the Riccar website at www.riccar.com.**

THIS WARRANTY IS EXCLUSIVE AND IN LIEU OF ANY AND ALL OTHER WARRANTIES WHETHER WRITTEN, ORAL, EXPRESSED OR IMPLIED, (INCLUDING ANY WARRANTY OF MERCHANTABILITY OR FITNESS FOR A PARTICULAR PURPOSE). THIS WARRANTY DISCLAIMS LIABILITY FOR INCIDENTAL OR CONSEQUENTIAL DAMAGES.

How State Law Applies:

This warranty gives you specific legal rights, and you may also have other rights which vary from state to state.

Register your warranty online at www.riccar.com

Owner's Warranty Information

keep this for your records...

Date of purchase _____

Serial number _____

Model number _____

Purchased from:

Store name _____

Address _____

City, State, Zip _____

Telephone _____

RICCAR®



RICCAR®

www.riccar.com